



PUNTO FILO RANGE

Ventilatoare axiale de perete

Pentru ventilarea intermitenta sau continua a spatiilor mici sau medii, domestice sau comerciale.



Design: F.Trabucco & Associates

- 17 modele cu diametre cuprinse intre 90-150, standard, cu timer sau cu durata de viata prelungita
- Clapeta anti-retur deja instalata pe ventilator, previne intrarea nedorita a aerului inapoi atunci cand ventilatorul este oprit
- Foarte silentios
- Instalare usoara si rapida
- Eco-friendly: garanteaza un impact minor asupra mediului
- Doar 17 mm grosime
- Punto Filo T-HCS: 3 modele
- Valoare a umiditatii reglabila: 60%, 70%, 80%, 90% prin intermediul unui buton in momentul instalarii
- Protectie: IPX4
- Clasa izolatie: II. □

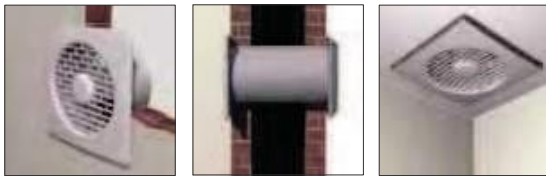

DATE TEHNICE

Model	V~50Hz	W	A	RPM	Debit maxim		Presiune maxima		Lp dB(A) 3m	Max °C
					m³/h	l/s	mmH₂O	Pa		
MF 90/3.5"	230 - 240	14	0.08	2500	65	18	2.5	25	28.8	50
MF 100/4"		15	0.09	2400	85	24	3	29	31	
MF 120/5"		20	0.12	2150	175	49	5	49	34.4	
MF 150/6"		28	0.15	2100	335	93	6	59	40.1	

DIMENSIUNI

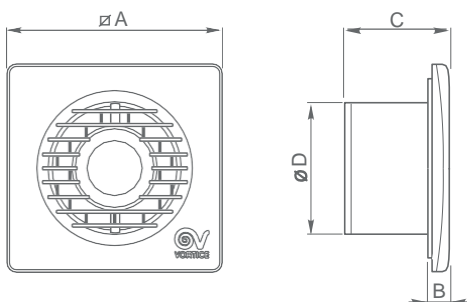



Model	∅ A	B	C	∅ D	Kg
MF 90/3.5"	159	17	77	92.5	0.50
MF 100/4"				98	0.51
MF 120/5"	179		89	119	0.61
MF 150/6"	214		96	156	0.97

Dimensiuni (mm)



Punto Filo		STANDARD	LONG LIFE 30.000 h
Ø90	Basic	11122	-
	Timer	11126	-
Ø100	Basic	11123	11131
	Timer	11127	11135
	Timer PIR	-	11185
	Timer HCS	-	11139
Ø120	Basic	11124	11132
	Timer	11128	11136
	Timer PIR	-	11186
	Timer HCS	-	11149
Ø150	Basic	11125	11133
	Timer	11129	11137
	Timer PIR	-	11187
	Timer HCS	-	11176

ACCESORII PRODUS

Model	Cod	Produs
	C 1.5 Regulator de viteza 1.5 A 12966	MF 90/3.5" Cod 11122 MF 90/3.5" T Cod 11126 MF 100/4" Cod 11123 MF 100/4" LL Cod 11131 MF 100/4" T Cod 11127 MF 100/4" T LL Cod 11135 MF 100/4" T P LL Cod 11185 MF 100/4" T-HCS LL Cod 11135 MF 120/5" Cod 11124 MF 120/5" LL Cod 11132 MF 120/5" T Cod 11128 MF 120/5" T LL Cod 11136 MF 120/5" T P LL Cod 11149 MF 120/5" T-HCS LL Cod 11136 MF 150/6" Cod 11125 MF 150/6" LL Cod 11133 MF 150/6" T Cod 11129 MF 150/6" T LL Cod 11137 MF 150/6" T P LL Cod 11187 MF 150/6" T-HCS LL Cod 11176
	SCB KIT adaptor incastabil pentru C 1.5 22481	12966
	SF 90-100 Kit pentru tavan Ø 90-100 22162	• • • • • • •
	SF 120 Kit pentru tavan Ø 120 22163	• • • • •
	SF 150 Kit pentru tavan Ø 150 22164	• • • • • •

CURBE DE PERFORMANTA

MF 90/3.5"

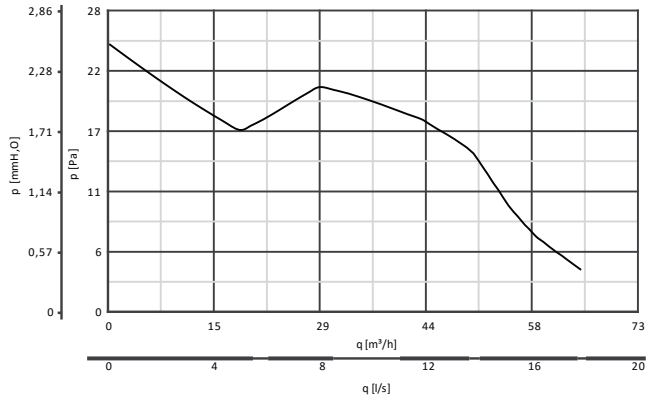

MF 100/4"

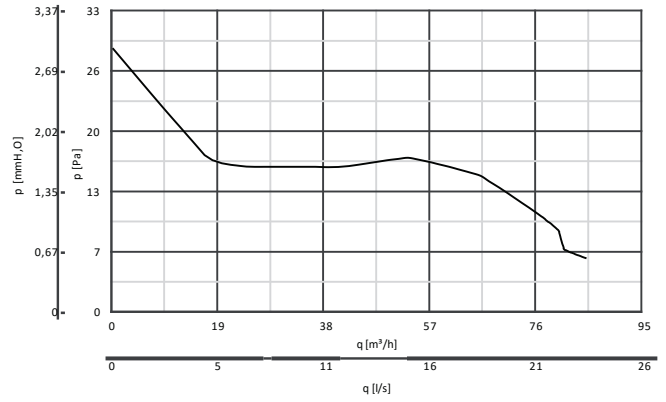

MF 120/5"

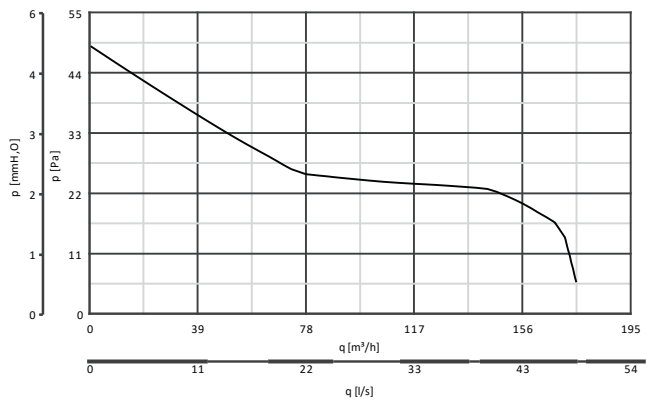

MF 150/6"

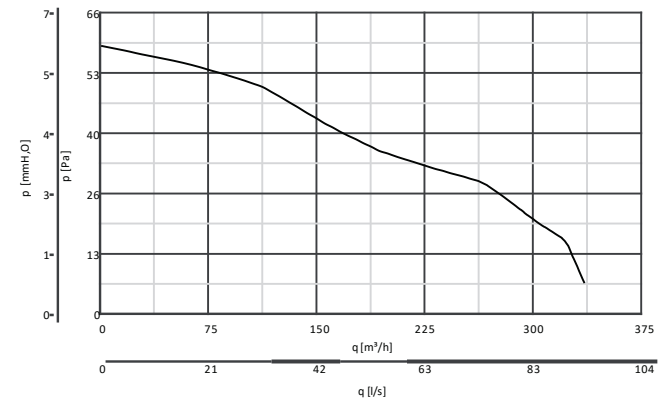

— presiune statica